



**VMR 1-8x28 FFP MRAD**  
**VMR 1-8x28 FFP MOA**

---

**USER MANUAL**

ENGLISH (EN)



Choosing the right optic is more than a gear decision. It affects your performance, your confidence, and, in critical moments, your safety. When you rely on your equipment in demanding environments, you need optics that work without hesitation. Too many products are built for specifications and marketing claims instead of real-world use. That leads to complexity, inconsistency, and failure when conditions are least forgiving. Colt Optics was built to solve that problem. By listening to shooters in the field and studying how optics perform under stress, we design products that prioritize clarity, durability, and simplicity. Every component is engineered to hold zero, resist impact, and deliver dependable performance in harsh conditions. The result is an optic you can trust when it matters most.

## Engineered for Real-World Performance

Every Colt Optics product is developed by engineers and industry professionals with hands-on experience in tactical and field environments. Our focus is simple: help you acquire targets faster, identify them more clearly, and maintain confidence in your equipment under pressure. Through advanced modeling

advanced modeling and extensive testing, our optics deliver sharp resolution across the entire field of view, reliable eye relief and forgiving exit pupil, consistent performance from any shooting position, and fast, accurate target acquisition in low light and high stress. This means less time adjusting and more time focusing on the task at hand.

## Precision You Can Rely On

Each lens is designed with exact curvature and precise centering, then manufactured from premium optical glass and treated with advanced coatings for maximum light transmission and contrast. With over 92 percent light transmission, Colt Optics provides clear, detailed images from first light to last. Targets remain distinguishable, reticles remain crisp, and visual fatigue is reduced during extended use. Our optical systems are integrated into rugged mechanical and electronic platforms, assembled under disciplined quality controls, and verified through rigorous testing. Every optic is built to withstand recoil, environmental exposure, and long-term use without loss of performance.

## Built for Confidence

Colt Optics products are not designed for display cases. They are built for shooters who depend on their equipment in demanding situations. Whether you are training, competing, hunting, or operating in professional environments, your optic should support your decisions, not complicate them. Our commitment is simple: deliver reliable, precise, and durable optics that help you perform at your best when it matters most.

Colt Optics-Make It Count

## TABLE OF CONTENTS

Specifications	6
Overview	7-8
Scope Mounting	9-10
Operation	11-17
Battery Installation	11
Illumination Adjustment	12
Magnification Adjustment	13
Diopter Adjustment	13
Zeroing Your Scope	14-15
Care and Maintenance	16
Warranty Information	17



**WARNING:** Read entire manual prior to installing and operating the scope.  
Make sure firearm is unloaded prior to installation.



## HIGHER DEFINITION IMAGE QUALITY

- › Quality German SCHOTT and Japanese OHARA Glass
- › Multi-coated Lenses for Optimal Scratch Resistance and to Minimize Glare and Reflection
- › Advanced 92% Light Transmission
- › Striking Edge-to-edge Clarity with High Contrast Resolution
- › Superior Wide-angle Field of View
- › Smooth, Consistent, and Accurate Zoom Cam Curve

## READY FOR WHEN AND WHERE IT COUNTS

- › IPX7 Waterproof Rated with -40°F (-40°C) to 160°F (71°C) Operational Range
- › .338 LAPUA Magnum Caliber Rated
- › Red Reticle Illumination
- › 12 Hour Automatic Shutoff

## TAILORED ERGONOMICS

- › Zero Resettable Windage and Elevation Turrets
- › Predictable, Tactile, and Audible Click Values
- › Serrated Turrets, Power Ring, and Eyepeice Diopter Optimized for Gloved Use
- › Integrated Throw Lever

## VMR 1-8x28 MRAD, MOA SPECIFICATIONS

Magnification	1X - 8X
Focal Plane	First Focal Plane
Length	10.9" / 277 mm
Tube Diameter	34 mm
Objective Diameter	28mm
Mounting Space Front	2.16" / 55.11 mm
Mounting Space Rear	2.64" / 67.09 mm
Weight (w/Battery)	25.25 oz / 716 g
Eye Relief	3.74" / 95 mm
Exit Pupil	10 mm - 3.5 mm
Linear FOV @ 100 Yds	115.5' - 14.1'
Linear FOV @ 100 m	38.5 m - 4.7 m
Angular FOV	21.8° - 2.7°
Diopter	-3D - +2D
Parallax	Preset @ 200 yds - 183 m
Elevation Travel (MRAD, MOA)	33 MRAD, 100 MOA
Windage Travel (MRAD, MOA)	22 MRAD, 50 MOA
Travel Per Revolution (MRAD, MOA)	10 MRAD, 50 MOA
Click Value (MRAD, MOA)	0.1 MRAD, 0.5 MOA
Reticle	HXT-28 MRAD, QR19 MOA
Illumination	Red (11 Settings)
Fogproof	Nitrogen Gas Purged
Waterproof	IPX7
Battery Type	CR2032

# OVERVIEW

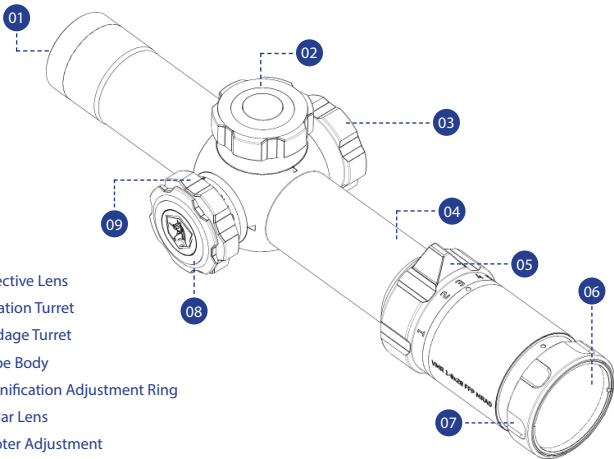

- 01 Objective Lens
- 02 Elevation Turret
- 03 Windage Turret
- 04 Scope Body
- 05 Magnification Adjustment Ring
- 06 Ocular Lens
- 07 Diopter Adjustment
- 08 Battery Compartment (Button Cell CR2032)
- 09 Illumination Knob

- 10 CR2032 Battery (Included)
- 11 Flip-open Lens Caps (Included)
- 12 Sunshade (Included)
- 13 Cleaning Cloth (Included)

## OVERVIEW

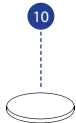
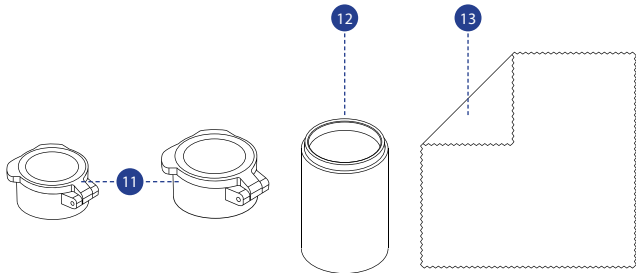

### **⚠ WARNING**

- **INGESTION HAZARD: DEATH** or serious injury can occur if ingested.
- A swallowed button cell or coin battery can cause **Internal Chemical Burns** in as little as **2 hours**.
- **KEEP** new and used batteries **OUT OF REACH OF CHILDREN**.
- **Seek immediate medical attention** if a battery is suspected to be swallowed or inserted inside any part of the body.
- For treatment information call: [phone number for the National Battery Ingestion Hotline, currently 1-(800) 498-8666].



## PROPER MOUNTING OF COLT OPTICS SCOPES TO SCOPE RINGS



**WARNING:** Read entire manual prior to installing and operating the scope. Make sure firearm is unloaded prior to installation.

### MOUNTING WITH REGULAR SCOPE RINGS

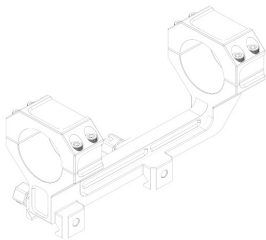

1. Mount the correct scope rings or mount to the firearm's rail whether it's a Picatinny, Weaver, or Dovetail mounting interface. Follow the recommended procedures provided by the scope rings or mount manufacturer.

2. Remove the top halves of the scope rings and place the scope within its saddle.

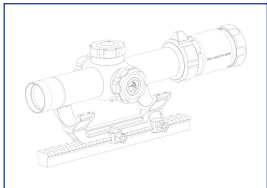
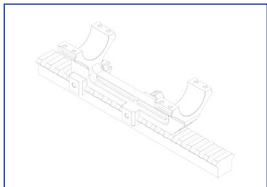

3. Reinstall the top halves with just enough torque to hold the scope in place, but still rotate along its axis and move forward and rearward in the saddle.

4. With a comfortable cheek weld and shooting posture, look through the scope and move it forward or backward within the saddle to adjust for eye relief. Once you can clearly see through the scope with bright and full sight picture and no peripheral “Black Ring”, proper eye relief is achieved. Repositioning the scope rings or mount on the firearm may be required in addition to the above to achieve proper eye relief.

5. Using a bubble leveler or other scope alignment tool or method, ensure the scope’s reticle alignment is not canted, but leveled with that of the firearm.

6. Secure the scope in place using a cross-torque pattern for the screws with proper correct torque value provided by the manufacturer.

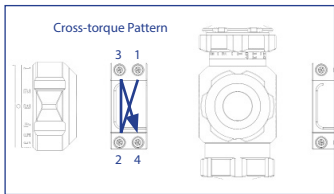
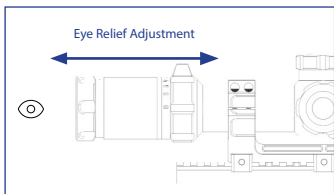
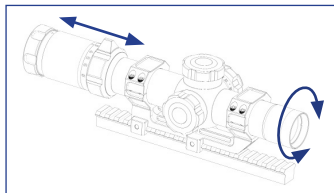

## OPERATION



**WARNING:** Read entire manual prior to installing and operating the scope. Make sure firearm is unloaded prior to installation.

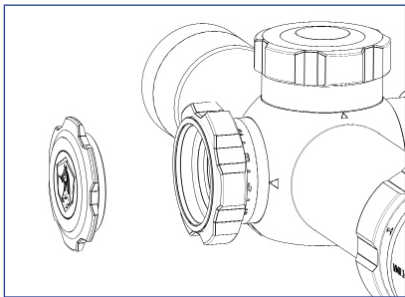

## BATTERY INSTALLATION

Turn the outer-most cap counterclockwise to access the battery compartment. With the + side facing outward, insert the CR2032 battery into the battery compartment until it is fully seated and captured by the metallic contacts. Note that upon seating the battery and looking through the scope, reticle illumination will have turned on even without the battery cap reinstalled yet. The illumination will be in its default red color. This will confirm that the battery is seated properly prior to reinstalling the battery cap. Reinstall the battery cap until snug.

## ILLUMINATION ADJUSTMENT

### 1. Powering On

To turn on reticle illumination, rotate the knob to one of the numbers. The reticle will illuminate red. The intensity of the illumination is dictated by the number. 11 is the brightest setting.

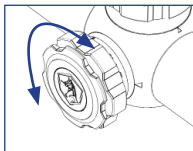

### 2. Adjusting Brightness Intensity

To adjust brightness intensity, simply rotate the knob between the 11 illumination settings to select the desired brightness. 11 is the brightest setting.

### 3. Powering Off

To turn off reticle illumination, turn the knob to one of the hash marks between the numbers on the knob.

### 4. Automatic Shutoff

Illumination will automatically shut off after 12 hours if left on. To turn illumination back on, simply rotate the illumination knob to one of the 11 brightness settings.

## MAGNIFICATION ADJUSTMENT

Adjust the magnification by rotating the power ring counterclockwise to zoom in and clockwise to zoom out.

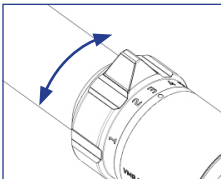

## DIOPTER ADJUSTMENT

- 1 Set the magnification ring to the 1x position.
- 2 Maintain a natural, heads-up shooting posture.
- 3 With both eyes open, view a distant object through and around the optic.
- 4 Rotate the diopter until the image through the scope matches the unaided eye (no perceived magnification or reduction).
- 5 The goal is for the scope image to appear true 1x, seamless, and distortion-free.
- 6 Confirm by rapidly transitioning between eyes and verifying no visual shift.
- 7 Lock the diopter if applicable.

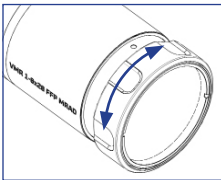

## ZEROING YOUR SCOPE

Your VMR 1-8x28 uses 0.1 MRAD/0.5 MOA per click windage & elevation (W/E) turrets. The laser engraved numbers on the face of the turrets refer to directional change in point of impact (POI).

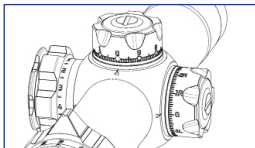

### 1. Zeroing Procedure

With the W/E turrets, zero optic until your point-of-aim (POA) equals point-of-impact (POI) at your intended target distance.

If bore-sighting or getting on paper at a closer distance first, be sure to confirm your zero at your actual intended target distance after.

#### a. Resetting Elevation Zero Indicator

Loosen the cap on the turret until it can be removed. Pull the turret knob off and reindex the "0" on the turret knob to the "0" mark on the scope body. Once the zero marks are aligned, reassemble the turret by threading the cap through the turret knob to fix the assembly back on to the scope. Do not overtighten.



## b. Resetting Windage Zero Indicator

Loosen the cap on the turret until it can be removed.

Pull the turret knob off and reindex the "0" on the turret knob to the "0" mark on the scope body.

Once the zero marks are aligned, reassemble the turret by threading the cap through the turret knob to fix the assembly back onto the scope. Do not overtighten.

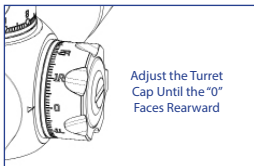
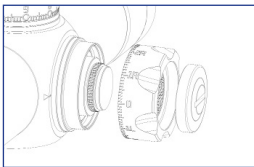

## c. Quick Guide: Zeroing

1. Zero elevation and windage until your point of aim (POA) = point of impact (POI) at your intended target distance.

If bore-sighting or getting on paper at a closer distance first, be sure to confirm your zero at your actual intended target distance after.

2. Reset elevation "0" indicator. See instructions above.
3. Reset windage "0" indicator. See instructions above.
4. The scope zeroing procedure is now complete.

## CARE AND MAINTENANCE

**LENSES:** To clean lenses, remove any large particles with an optical lens brush. To remove fine particles, use the provided microfiber cloth. If the cloth becomes soiled, wash in lukewarm soapy water and leave to air dry. To further clean the lenses, you may use pure alcohol, high-grade glass cleaner, or distilled water on a cotton swab. To ensure long-lasting high performance, keep lens surfaces free of dirt, oil, grease, etc.

**NOTE:** To best protect the lenses, close the provided lens caps when the scope is not in use.

**ADJUSTABLE FEATURES:** When any adjustment turret is loosened, keep it free of any liquids, dirt, or dust debris.

**SCOPE BODY:** If dirt, dust, fingerprints, etc. accumulate on the scope body, simply wipe the body down with a clean dry cloth. Do not use the included microfiber cloth.

**STORAGE:** Store your scope in a well-ventilated, dry, and dark place. If the scope is wet, dry the scope prior to storage. If storing for an extended period of time, remove the battery from the scope.

# WARRANTY

## Colt Optics Lifetime Warranty Statement

Colt Optics stands behind the quality and performance of our optics and accessories. Each optic is backed by a Limited Lifetime Warranty covering mechanical and optical defects in materials and workmanship under normal use for the life of the product. If a covered defect is confirmed after inspection, we will, at our discretion, repair the product at no charge to the original purchaser, or replace it with the same or a comparable model at no charge.

## Electronic Components

Integrated electronic components (illumination and control modules) are covered by a limited warranty of two (2) years for professional use and five (5) years for commercial use from the date of purchase, protecting against defects in materials or workmanship.

## Warranty Exclusions

This warranty does not apply to or cover:

- Normal wear and tear
- Use with non-approved accessories, or component
- Intentional, accidental, deliberate, or cosmetic damage
- Misuse, abuse, negligence, or improper mounting
- Loss/theft, acts of God, normal wear
- Consumables (batteries/caps/covers)
- Unauthorized repairs, alterations, or disassembly beyond normal maintenance
- Removal, alteration, or destruction of the serial number

**COLT OPTICS**®

MAKE IT COUNT